

## Vision Measuring Systems QUICK SCOPE QS-L





## Height measurement now available from one machine

High-speed image auto focus achieving height measurement now standard equipment. Measurements thus far performed separately using an optical measuring instrument and an indicator are now integrated into one machine.

## Reliable small-parts measurement

High-speed 7X optical zoom with an interchangeable objective lens unit provides sharp and bright images. Measures details that cannot even be recognized when using digital zoom.

## Highlights hard-to-see edges

High-intensity 4-quadrant LED ring light generates shadows to highlight edges that otherwise would be practically invisible.



# Vision Measuring Systems QUICK SCOPE QS-L

# Problems with simple dimensional measuring devices

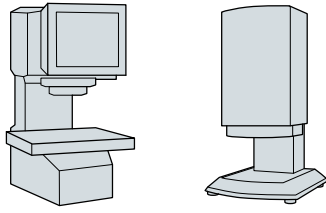

## Problems

### ✓ Hard to measure reliably using regular microscope lighting

Some edges cannot be accurately detected and captured when using only the ring light as edge height and shape are so variable.

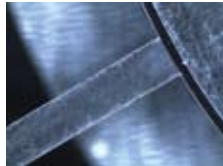

Indistinct image using ring light

### ✓ Cannot measure micro dimensions due to low magnification

Some micro forms cannot be measured with only a digital zoom.

Measurement of the width of micro-recessed-forms cannot be accurately performed due to low magnification



### ✓ Edge measurement of a stepped feature cannot be performed correctly

Some desired edge contrast cannot be obtained with a simple dimension measuring device that has generally low magnification due to deep focus depth



### ✓ Height measurement results are not stable

Height measurement with a contact probe

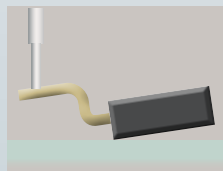

### ✓ Unsure about the integrity of measurement results to be submitted to customers

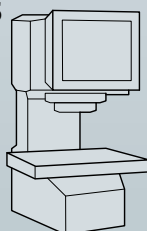

## QS-L solutions



### Edge measurement using a combination of co-axial light, ring light and transmitted light



Positive edge detection with co-axial light

### 7X optical zoom unit with interchangeable objective lenses enables measuring small parts



Edge capture with the ideal magnification is always available



Measurement of micro radii is easy with the correct magnification

### Edges can easily be captured with the interchangeable objective lens zoom unit



Measurement with optimized optical zoom is available

### Image auto focus function is equipped as standard

Image auto focus offers sure and highly accurate measurement of target height with the minimum clamping of a workpiece

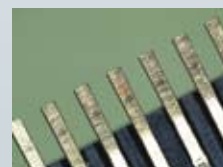
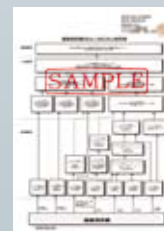

	Image auto focus
Measurement accuracy in the Z-axis	(4.5+0.006L) μm

### Mitutoyo provides inspection/calibration services using reference instruments that are traceable to the national standard



# Generic technology realizes accurate measurement

**7X optical zoom unit with interchangeable objective lenses** offers reliable small-parts measurement

Newly designed 7X optical zoom unit with interchangeable objective lenses securely captures measurement targets from wide-field to micro form. In addition, 4X digital zoom is available using software.

## Cutting tool



## Plastic molded article

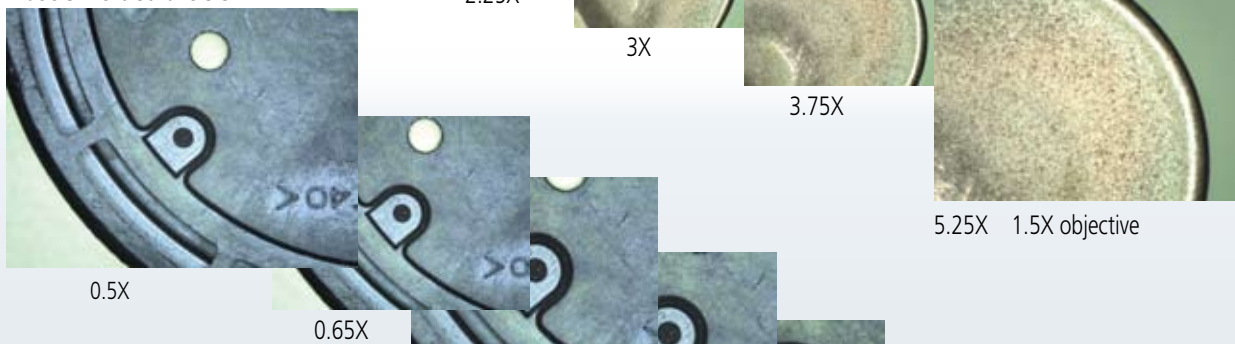

## LED device

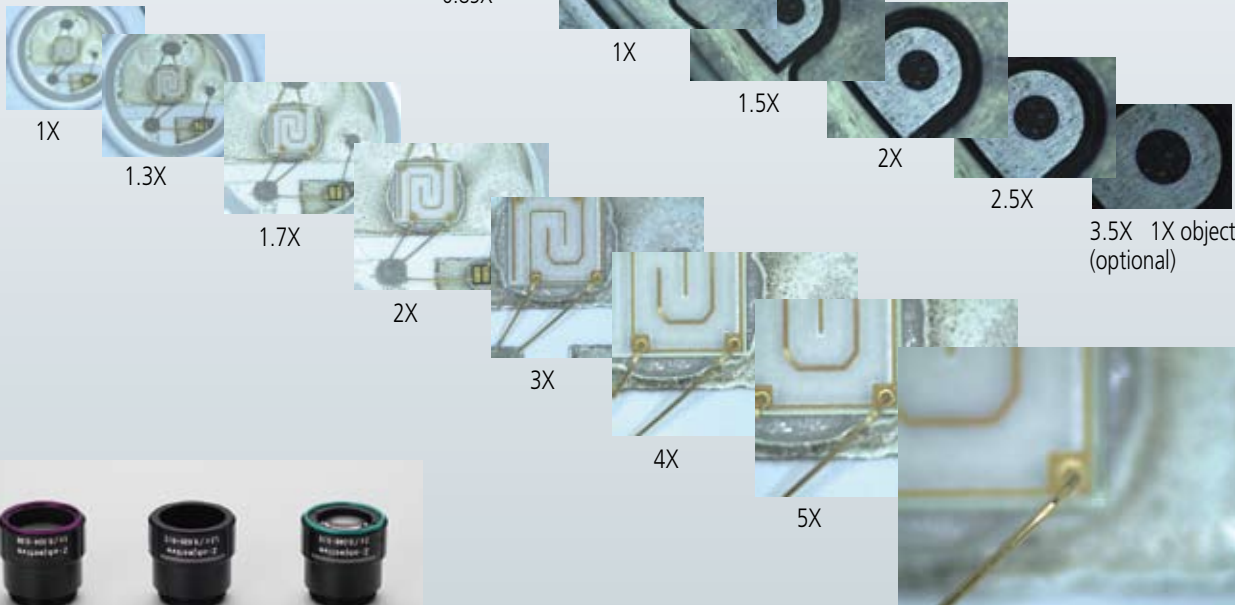

Optical zoom magnification		0.5X	0.65X	0.75X	0.85X	0.98X	1X	1.28X	1.3X	1.5X	1.7X	2X	2.25X	2.5X	3X	3.5X	3.75X	4X	5X	5.25X	7X
View field (mm)	Horizontal (H)	13.10	10.08	8.73	7.71	6.72	6.55	5.14	5.04	4.37	3.85	3.28	2.91	2.62	2.18	1.87	1.75	1.64	1.31	1.25	0.94
	Vertical (V)	9.84	7.57	6.56	5.79	5.05	4.92	3.86	3.78	3.28	2.89	2.46	2.19	1.97	1.64	1.41	1.31	1.23	0.98	0.94	0.70
Total magnification (on the monitor)		19	25	29	33	38	38.5	49.5	50	58	65.5	77	87	96	116	135	145	154	193	202	270
Objective lens	1X objective (optional) Working distance	74 mm																			
	1.5X objective (standard accessory) Working distance	42 mm																			
	2X objective (optional) Working distance	42 mm																			

Note: The total magnification indicates the magnification on the monitor when the QSPAK video window size is the default 252.7 x 214.9 mm.

## High-speed image auto focus enables highly accurate height measurement

Since non-contact measurement requires only the minimum clamping of the workpiece, height measurement can be performed efficiently. Also, in contrast with laser-equipped measuring devices, height measurement is less influenced by the surface roughness of the workpiece.

	Image auto focus
Measurement accuracy in Z-axis	(4.5+0.006L) μm

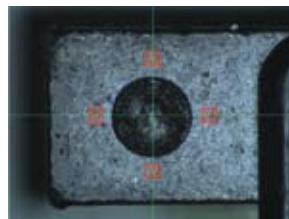
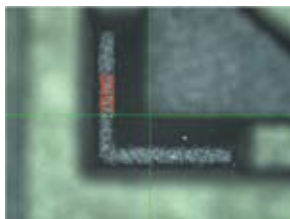
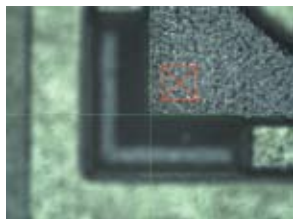

Sectional view

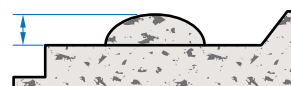
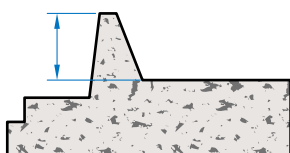

## LED light unit offers a high degree of freedom for reliable edge measurement

The view may vary depending on the type of method used for lighting the workpiece.

The **QS-L** can capture edges accurately by switching between transmitted lighting, co-axial lighting and ring lighting.



Transmitted light



Co-axial light



Ring light

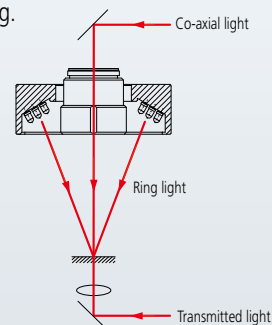

### 4-quadrant LED ring light



Back

Front

Right

Left

### Lighting tool (Contrast and brightness)

The lighting tool offers automatic setting of the ideal light intensity so that constant brightness can be maintained. It also eliminates data dispersion caused by lighting conditions.

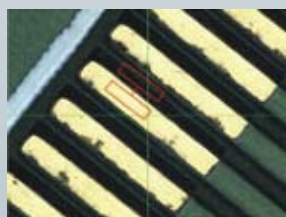

Dual-area contrast tool



Brightness tool



# Software enables easy operation and reliable measurement QSPAK

## Large screen makes detailed operations easy

All the functions needed for measurement are displayed on one screen; measurement can be performed by simply moving the mouse. Large images enable users to measure details with ease.



## Many commands enable fast measurement

A wide choice of commands including various distance and intersection point measurements enables easy and reliable measurement.

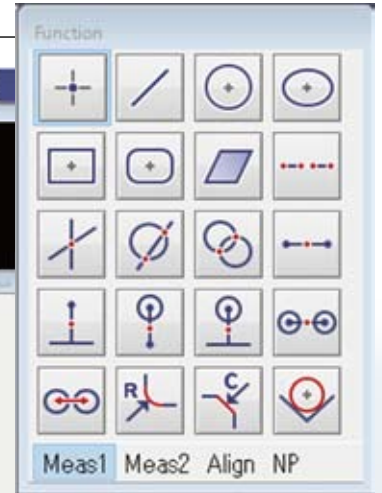

## Eliminates confusion between results and points

Since measurement result images are displayed, confusing results that can occur with just showing measuring points can be eliminated.

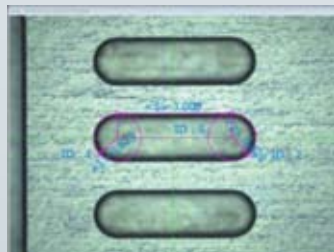

## One-click edge detection

Circles, lines and dots around the measurement point can be read out instantly with one-click of the mouse.

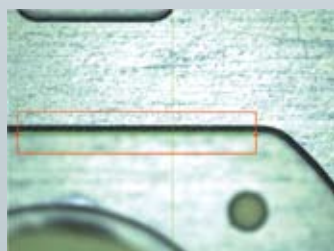

One-click line tool

## Detection tools matched to targets

Detection tools can be selected according to the measuring point in order to capture edges with high accuracy.

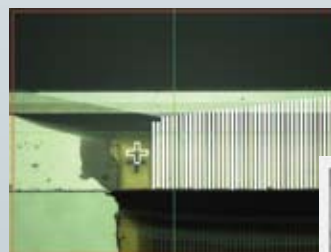

Pattern tool

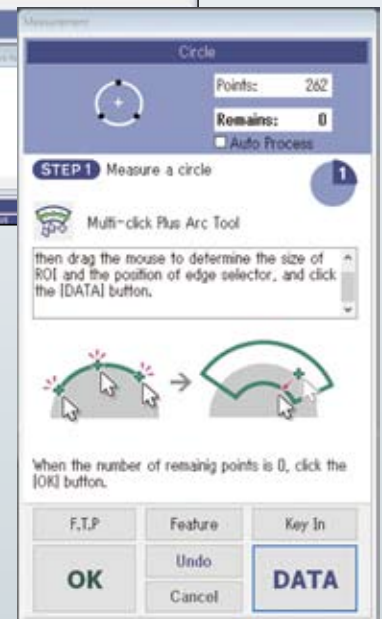

## User-friendly operation guidance

When a command is selected, an explanation of the corresponding operation method is provided.

## Remove influence from breakage and burrs by excluding abnormal points

Erroneous measurement points caused by dust adhering to a workpiece including breakage and burrs are automatically removed. The removal threshold can also be set easily.

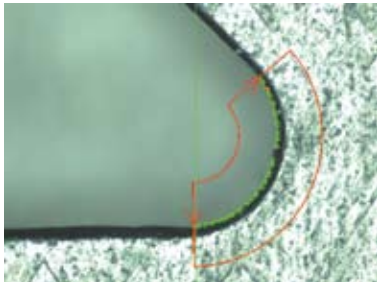

## Template function

The template function making forms visible is featured for the first time.

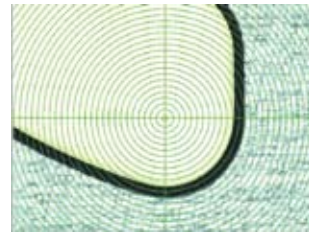

Concentric circle template

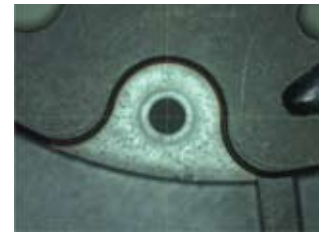

User template

## Form tolerance is also supported

The auto trace tool enables tracking and acquiring contours on the screen by copying automatically.



In addition

### Option

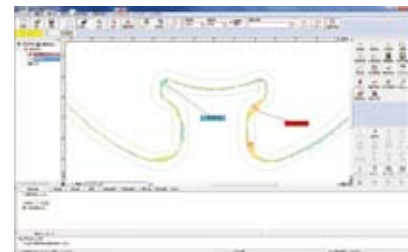

The **FORMTRACEPAK-AP** optional analysis software can provide advanced dimensional analysis.

## Identifies desired measuring points quickly

Measuring points can be quickly found in the graphical window. Operations on measured elements using graphics can also be performed easily.

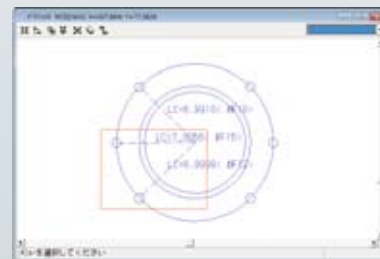
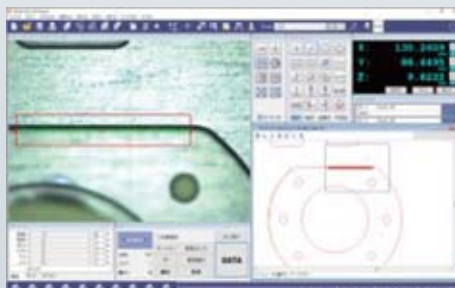

## Totalization of daily measurements can be easily performed

CSV output of measurement results is available so that they can be used for statistical data processing with Excel.

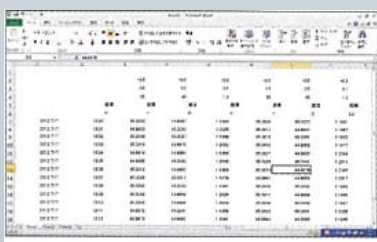

In addition

### Option

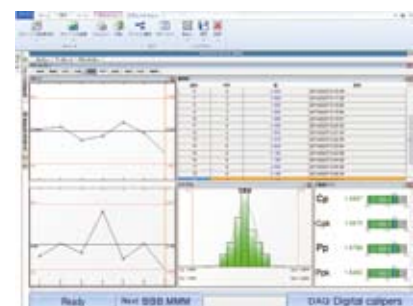

The optional **MeasurLink** software provides the statistical process control (SPC) control charts, histograms and process capability indexes.

# Manual Vision Measuring Machine with Motor-operated Z-axis QS-L/AFC



## Specifications

Model	QS-L2010Z/AFC	QS-L3017Z/AFC	QS-L4020Z/AFC
Order No.	359-713 -10	359-714 -10	359-715-10
Drive method	XY axes: Manual Z axis: CNC with Auto focus		
Measuring volume	200×100×150 mm	300×170×150 mm	400×200×150 mm
Resolution / Scale type	0.1 μm / Linear encoder		
Accuracy *1*2	X axis, Y axis	(2.2+0.02L) μm	
	Z axis	(4.5+0.006L) μm	
Accuracy guaranteed temperature range	20±1 °C		
Observation unit *3	7X zoom (8 steps) interchangeable objective lenses (1X objective 0.5X - 3.5X; 1.5X objective 0.75X - 5.25X; 2X objective 1X - 7X)		
Image sensor	3 Megapixel, CMOS color camera		
Illumination	Transmitted light	white LED	
	Co-axial light	white LED	
	Ring light	4-quadrant ring light (LED)	
Dimensions (main unit, WxDxH)	624×711×729 mm	692×857×837 mm	757×867×837 mm
Stage glass size	250×150 mm	370×240 mm	450×240 mm
Maximum stage loading	10 kg	20 kg	15 kg
Mass (main unit)	70 kg	160 kg	167 kg

\*1: Inspected to Mitutoyo standard. L = measuring length (mm)

\*2: 3X lens magnification or greater

\*3: 1X and 2X objective lenses are optional

## Remote box





## External dimensions

### QS-L2010Z/AFC

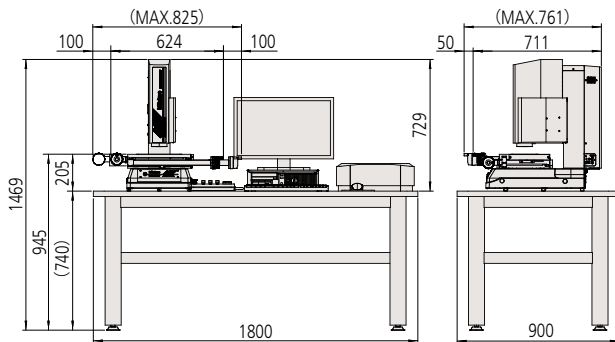

### QS-L3017Z/AFC

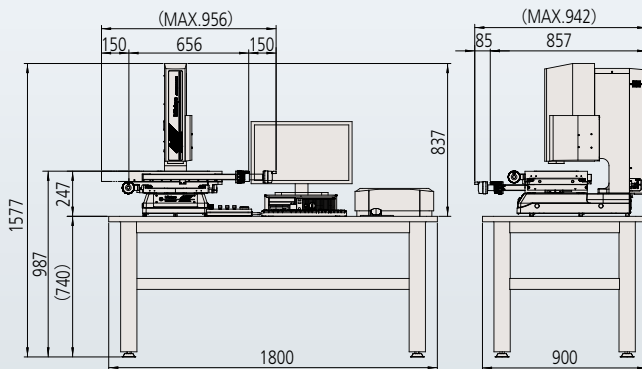

### QS-L4020Z/AFC

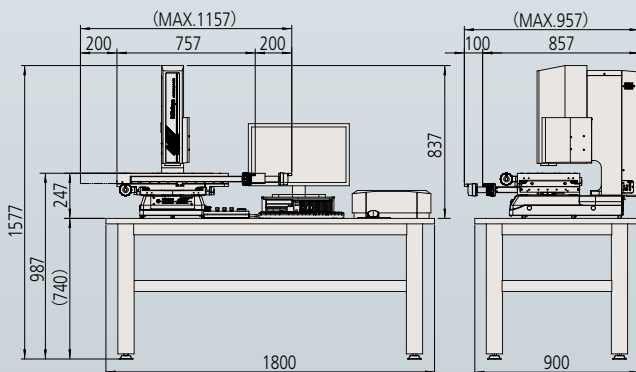

## Option

### ■ Calibration chart



Order No.	<b>02ATN695</b>
Application	This corrects the pixel size of the camera, the accuracy of automatic focusing at each magnification and optical axis offset.

### ■ Foot switch (Solid type)



Order No.	<b>12AAJ088</b>
-----------	-----------------

### ■ Turntable with fine adjustment (A), (B)

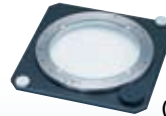

	(A)	(B)
Order No.	<b>176-305</b>	<b>176-306</b>
External dimensions	280(W)×280(D)×24(H) mm	342(W)×342(D)×23(H) mm
Effective glass size (mm)	ø182	ø238

Note) V-block stage, swivel center support and holder with clamp can be fixed on the table.

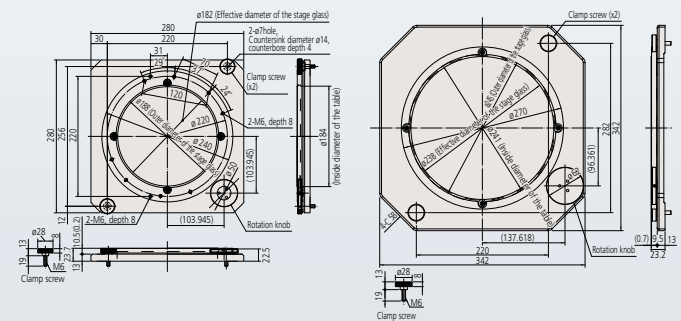

### ■ Holder with clamp

Order No.	<b>176-107</b>
Maximum length of the clamp	35 mm

### ■ V-block with clamp

Order No.	<b>172-378</b>
Maximum supportable diameter:	25 mm
Center height from the mounting surface:	38 - 48 mm

### ■ Swivel center support



Order No.	<b>172-197</b>
Application	±10° swivel is available, minimum readable angle 1° Suitable for measurement of screw

\* Adapter B (176-310) is separately required for size 2010.

\* Adapter B (176-304) is separately required for size 3017 and 4020.

### ■ Stage adapter Stage adapter B

Order No.	<b>Stage adapter: 176-304 Stage adapter B: 176-310</b>
Application	Some optional products require this be mounted on the measuring machine.

Note) A set consists of 2 sheets.

### ■ Exclusive table

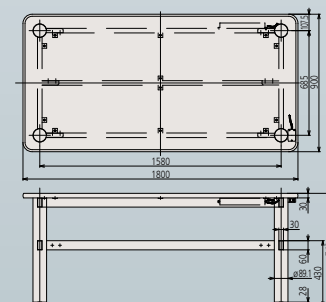

Order No.	<b>02ATE760</b>
External dimensions	1800(W)×900(D)×740(H) mm
Mass	60 kg

## Optional software

### FORMTRACEPAK-AP

Geometrical tolerance, contour degree evaluation and micro dimension analysis can be performed on the basis of the contour data obtained using a quick scope.

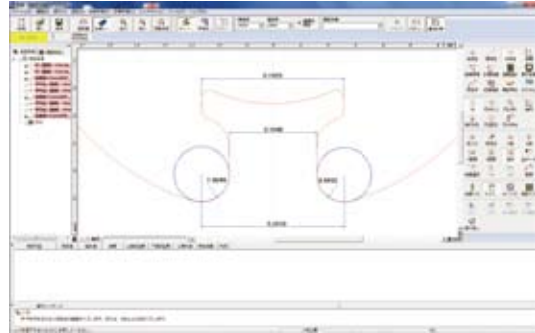
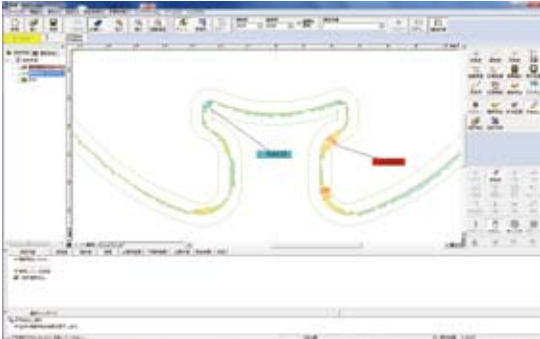

### MeasurLink Real-Time Professional

**MeasurLink Real-Time** is the Statistical Process Control (SPC) software that displays statistical processing results including control charts, histograms and process capability indexes in real-time based on data collected through the quick scope and measuring devices and systems. The software helps prevent generating scrap by tracking dimension variation trends so that early preventive action can be taken when a process is seen to be about to produce product outside the tolerance limits.

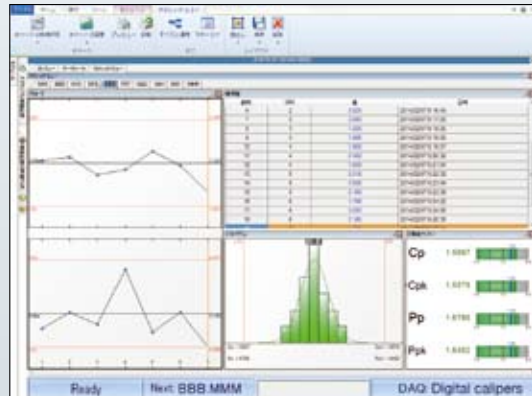
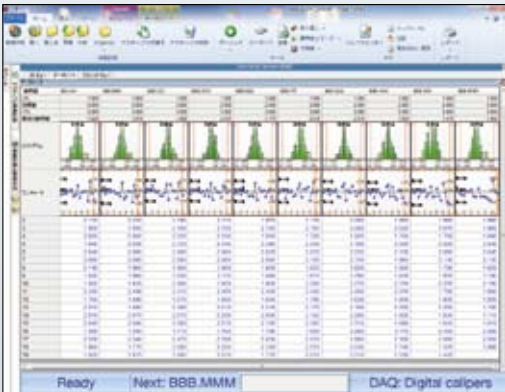

### QS-CAD I/F

- Specifies the current observation point corresponding to stage position information.
- Can extract design information from graphic elements and omit key input during verification.
- Output of measurement results as CAD data is available.



### Measure Report

This software creates inspection sheets from data collected by measuring devices and systems including the quick scope, using a layout offering a high degree of freedom.

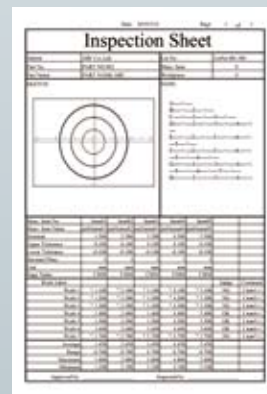

## Traceability

### Traceability to the national standard of length

- Mitutoyo owns standard scales that are traceable to the national standard of length and these are used to calibrate the reference gages used for calibration of measuring instruments, thus establishing and maintaining traceability for each instrument.
- Our calibration organizations are accredited by IAJapan, a signatory to the Mutual Recognition Arrangement (MRA) of the International Laboratory Accreditation Cooperation (ILAC), and approved of as having measurement skills equivalent to those of overseas organizations.

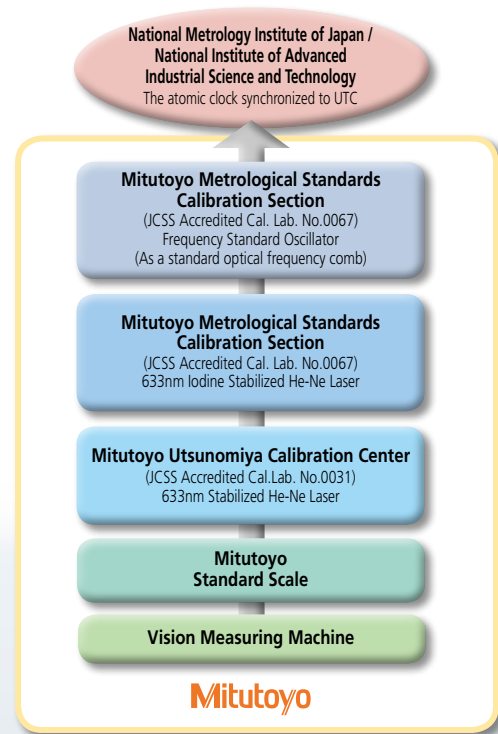

## Reliable support system

### The world's top-level global network

Following the establishment of MTI Corporation (U.S.) in 1963, Mitutoyo has been expanding its market presence throughout the world. Currently, the company has R&D, manufacturing, sales, and engineering service bases in 29 countries, as well as a network of distributors in some 80 countries. Mitutoyo maintains its rock-solid status as a leading global manufacturer providing services tailored to each regional society.



Headquarters





**Whatever your challenges are, Mitutoyo supports you from start to finish.**

Mitutoyo is not only a manufacturer of top quality measuring products but one that also offers qualified support for the lifetime of the equipment, backed up by comprehensive services that ensure your staff can make the very best use of the investment.

Apart from the basics of calibration and repair, Mitutoyo offers product and metrology training, as well as IT support for the sophisticated software used in modern measuring technology. We can also design, build, test and deliver bespoke measuring solutions and even, if deemed cost-effective, take your critical measurement challenges in-house on a sub-contract basis.



**Find additional product literature and our product catalogue**

<http://www.mitutoyo.co.jp/global.html>

**Our products are classified as regulated items under Japanese Foreign Exchange and Foreign Trade Law. Please consult us in advance if you wish to export our products to any other country.  
If the purchased product is exported, even though it is not a regulated item (Catch-All controls item), the customer service available for that product may be affected. If you have any questions, please consult your local Mitutoyo sales office.**

Note: Product illustrations are without obligation. Product descriptions, in particular any and all technical specifications, are only binding when explicitly agreed upon. MITUTOYO and MICAT are either registered trademarks or trademarks of Mitutoyo Corp. in Japan and/or other countries/regions.

Other product, company and brand names mentioned herein are for identification purposes only and may be the trademarks of their respective holders.

# Mitutoyo

## Mitutoyo Corporation

20-1, Sakado 1-Chome,  
Takatsu-ku, Kawasaki-shi,  
Kanagawa 213-8533, Japan

T +81 (0) 44 813-8230

F +81 (0) 44 813-8231

<http://www.mitutoyo.co.jp>